

WORX®

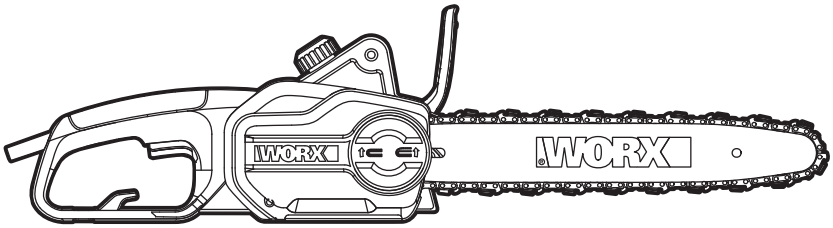

2 in 1: Pole Saw / Chain Saw	EN	P07
Scie sur manche et tronçonneuse 2 en 1	F	P24
2 en 1: sierra de pértiga/sierra de cadena	ES	P43



HELPLINE NUMBER
NUMERO DU SERVICE D'ASSISTANCE
NUMERO DE LINEA DE AYUDA
1-866-354-WORX (9679)

WG309 WG310



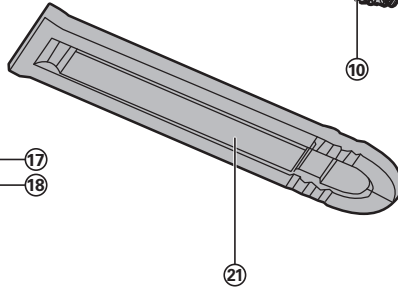
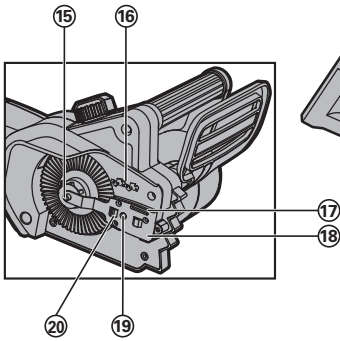
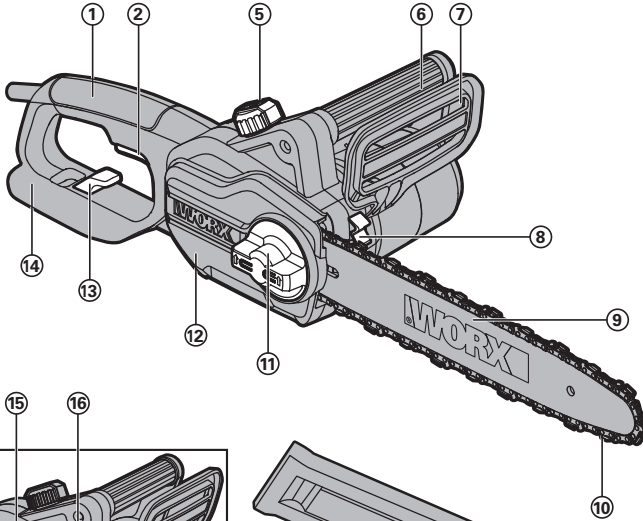
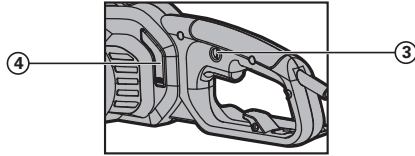

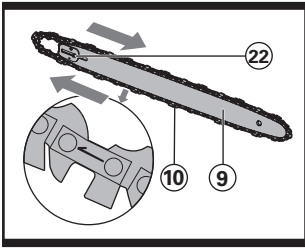

A

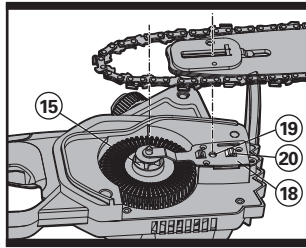

B

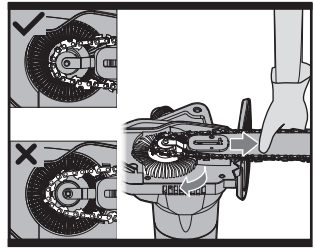

C

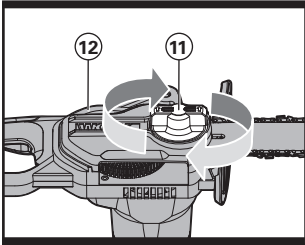

D

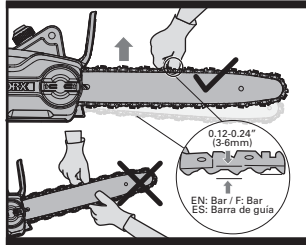

E

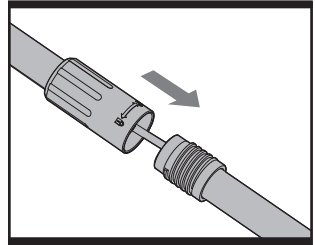

F1

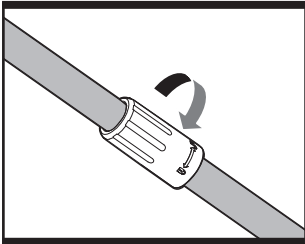

F2

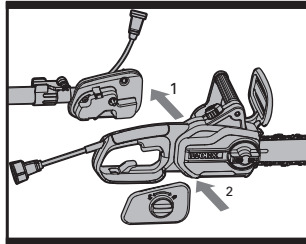

G1

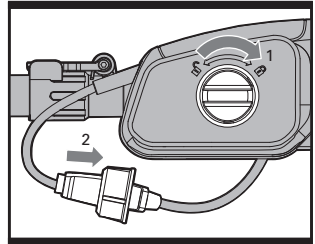

G2

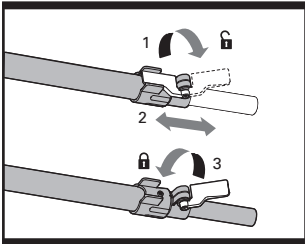

H

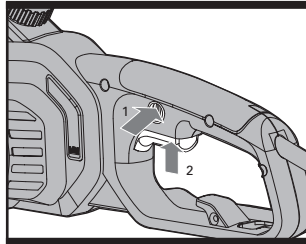

I

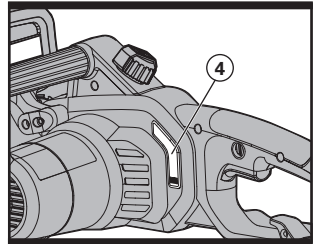

J1

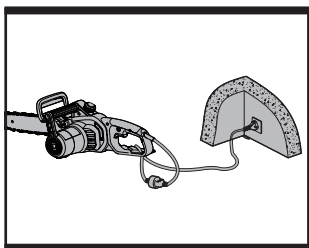

J2

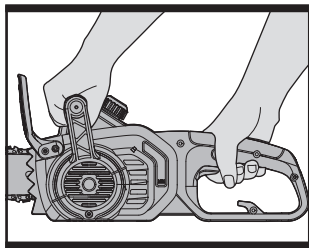

J3

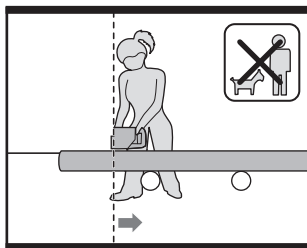

K1

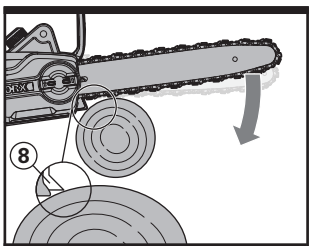

K2

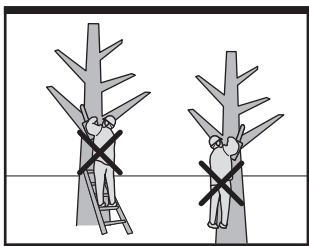

K3

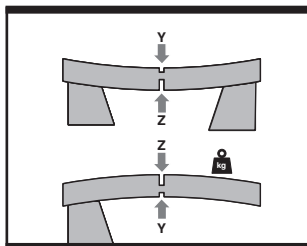

L

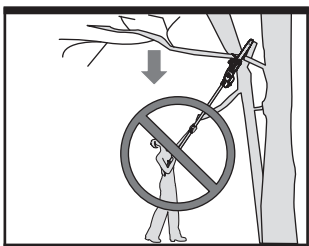

M1

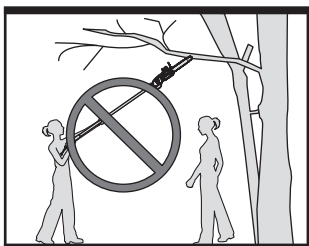

M2

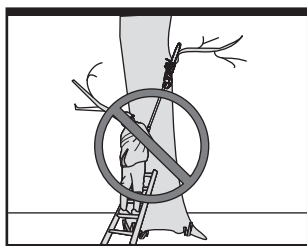

M3

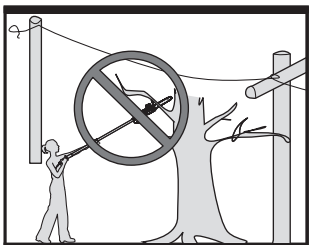

M4

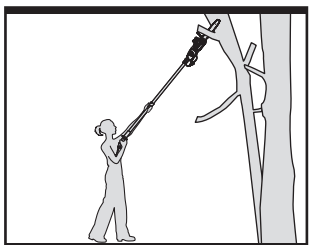

M5

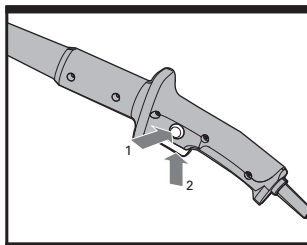

M6

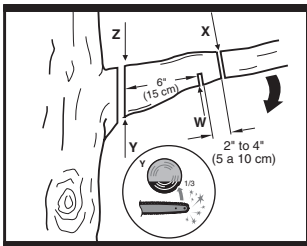

M7

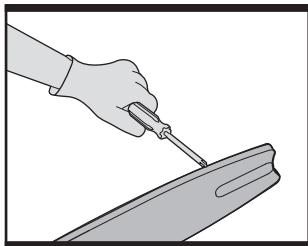

N

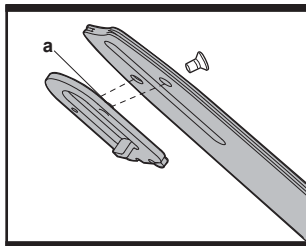

O

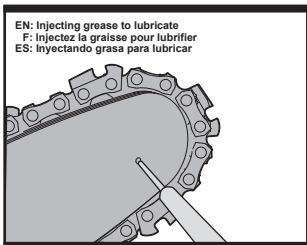

EN: Injecting grease to lubricate
 F: Injectez la graisse pour lubrifier
 ES: Inyectando grasa para lubricar

P

-
- 1. REAR HANDLE**

 - 2. ON/OFF SWITCH**

 - 3. LOCK-OFF BUTTON**

 - 4. OIL LEVEL WINDOW**

 - 5. OIL FILLER CAP**

 - 6. FRONT HANDLE**

 - 7. HAND GUARD**

 - 8. BUMPER SPIKE**

 - 9. GUIDE BAR**

 - 10. CHAIN**

 - 11. CHAIN TENSIONING KNOB**

 - 12. CHAIN COVER**

 - 13. EXTENSION CORD HOLDER**

 - 14. REAR HAND GUARD**

 - 15. DRIVE SPROCKET**

 - 16. CHAIN DIRECTION SYMBOL**

 - 17. OIL OUTLET**

 - 18. BAR CLAMP**

 - 19. FASTENING BAR BOLT**

 - 20. BAR LOCATING TABS**

 - 21. BAR AND CHAIN STORAGE/TRANSPORTATION COVER**

 - 22. BAR TENSIONING PLATE (SEE FIG. A)**

 - 23. EXTENSION POLE HANDLE**

 - 24. LOCKING COLLAR**

 - 25. CLAMPING LEVER**

 - 26. INNER POLE**

 - 27. HANDLE BRACKET**

 - 28. KNOB**

 - 29. RECEPTACLE CORD**
-

* Not all the accessories illustrated or described are included in standard delivery.

TECHNICAL DATA

	WG309	WG310
Voltage	120V~60Hz	
Amps	8Amp	
Bar length	10"	8"
Chain speed	28ft/s	
Oil tank capacity	4.06ounces	
Chain pitch	3/8"	
Number of chain links	40	34
Chain gauge	0.050"	0.043"
Chain type	QIRUI: A1-40 KANGXIN: 3/8LP-40 ES: 3/8LP050 40E	QIRUI: A0-34 KANGXIN: 3/8.043-34 ES: 3/8LP043 34E
Bar type	QIRUI: P010-50SR KANGXIN: AP10-40-507P ES: ES100SDEA041	QIRUI: P08-43SR KANGXIN: AP08-34-437P ES: ES084SDEA041
Weight(chain & bar included)	10lbs	9.5lbs
Protection class	 /II	

8 ACCESSORIES

Chain	1
Bar	1
Transportation Cover	1
Extension Pole	1

Only use the appropriate accessories intended for this tool. Accessory information can be found on the product packaging, at a WORX dealer or on our website at www.worx.com.

 **WARNING: Some dust created by power sanding, sawing, grinding, drilling and other construction activities contains chemicals known to the state of California to cause cancer, birth defects or other reproductive harm.**

Some examples of these chemicals are:

- **Lead from lead-based paints;**
- **Crystalline silica from bricks and cement and other masonry products and**
- **Arsenic and chromium from chemically-treated lumber.**

Your risk from these exposures varies, depending on how often you do this type of work. To reduce your exposure to these chemical:

- **Work in a well ventilated area, and**
- **Work with approved safety equipment, such as those dust masks that are specially designed to filter out microscopic particles.**

 **WARNING: This product may contain lead, phthalate or other chemicals known to the State of California to cause cancer, birth defects and other reproductive harm. Please wash your hands after use.**

GENERAL POWER TOOL SAFETY WARNINGS

 **WARNING: Read all safety warnings and instructions.** Failure to follow

the warnings and instructions may result in electric shock, fire and/or serious injury.

Save all warnings and instructions for future reference.

The term power tool in the warnings refer to your electric (corded) power tool or battery-operated (cordless) power tool.

1) Work area safety

a) Keep work area clean and well lit.

Cluttered or dark areas invite accidents.

- #### b) Do not operate power tools in explosive atmospheres, such as in the presence of flammable liquids, gases or dust.
- Power tools create sparks which

may ignite the dust or fumes.

- #### c) Keep children and bystanders away while operating a power tool.
- Distractions can cause you to lose control.

2) Electrical safety

- #### a) Power tool plugs must match the outlet. Never modify the plug in any way. Do not use any adapter plugs with grounded power tools.

Unmodified plugs and matching outlets will reduce risk of electric shock.

- #### b) Avoid body contact with grounded surfaces such as pipes, radiators, ranges and refrigerators.
- There is an increased risk of electric shock if your body is grounded.

- #### c) Do not expose power tools to rain or wet conditions.
- Water entering a power tool will increase the risk of electric shock.

- #### d) Do not abuse the cord. Never use the cord for carrying, pulling or unplugging the power tool. Keep cord away from heat, oil, sharp edges or moving parts.
- Damaged or entangled cords increase the risk of electric shock.

- #### e) When operating a power tool outdoors, use an extension cord suitable for outdoor use.
- Use of a cord suitable for outdoor use reduces the risk of electric shock.

- #### f) If operating a power tool in a damp location is unavoidable, use a ground fault circuit interrupter (GFCI) protected supply.
- Use of an GFCI reduces the risk of electric shock.

3) Personal safety

- #### a) Stay alert, watch what you are doing and use common sense when operating a power tool. Do not use a power tool while you are tired or under the influence of drugs, alcohol or medication.
- A moment of inattention while operating power tools may result in serious personal injury.

- #### b) Use personal protective equipment. Always wear eye protection.
- Protective equipment such as dust mask, non-skid safety shoes, hard hat, or hearing

protection used for appropriate conditions will reduce personal injuries.

- c) Prevent unintentional starting. Ensure the switch is in the off-position before connecting to power source and/or battery pack, picking up or carrying the tool.** Carrying power tools with your finger on the switch or energizing power tools that have the switch on invites accidents.
- d) Remove any adjusting key or wrench before turning the power tool on.** A wrench or a key left attached to a rotating part of the power tool may result in personal injury.
- e) Do not overreach. Keep proper footing and balance at all times.** This enables better control of the power tool in unexpected situations.
- f) Dress properly. Do not wear loose clothing or jewelry. Keep your hair, clothing and gloves away from moving parts.** Loose clothes, jewelry or long hair can be caught in moving parts.
- g) If devices are provided for the connection of dust extraction and collection facilities, ensure these are connected and properly used.** Use of dust collection can reduce dust-related hazards.

4) Power tool use and care

- a) Do not force the power tool. Use the correct power tool for your application.** The correct power tool will do the job better and safer at the rate for which it was designed.
- b) Do not use the power tool if the switch does not turn it on and off.** Any power tool that cannot be controlled with the switch is dangerous and must be repaired.
- c) Disconnect the plug from the power source and/or the battery pack from the power tool before making any adjustments, changing accessories, or storing power tools.** Such preventive safety measures reduce the risk of starting the power tool accidentally.
- d) Store idle power tools out of the reach of children and do not allow**

persons unfamiliar with the power tool or these instructions to operate the power tool. Power tools are dangerous in the hands of untrained users.

- e) Maintain power tools. Check for misalignment or binding of moving parts, breakage of parts and any other condition that may affect the power tools operation. If damaged, have the power tool repaired before use.** Many accidents are caused by poorly maintained power tools.
- f) Keep cutting tools sharp and clean.** Properly maintained cutting tools with sharp cutting edges are less likely to bind and are easier to control.
- g) Use the power tool, accessories and tool bits etc., in accordance with these instructions and in the manner intended for the particular type of power tool, taking into account the working conditions and the work to be performed.** Use of the power tool for operations different from those intended could result in a hazardous situation.

5) Service

- a) Have your power tool serviced by a qualified repair person using only identical replacement parts.** This will ensure that the safety of the power tool is maintained.

CHAIN SAW SAFETY WARNINGS

- 1. Keep all parts of the body away from the saw chain when the chain saw is operating. Before you start the chain saw, make sure the saw chain is not contacting anything.** A moment of inattention while operating chain saws may cause entanglement of your clothing or body with the saw chain.
- 2. Always hold the chain saw with your right hand on the rear handle and your left hand on the front handle.** Holding the chain saw with a reversed hand configuration increases the risk of personal

injury and should never be done.

- 3. Hold the power tool by insulated gripping surfaces only, because the saw chain may contact hidden wiring or its own cord.** Saw chains contacting a live wire may make exposed metal parts of the power tool live and could give the operator an electric shock.
- 4. Wear safety glasses and hearing protection. Further protective equipment for head, hands, legs and feet is recommended.** Adequate protective clothing will reduce personal injury by flying debris or accidental contact with the saw chain.
- 5. Do not operate a chain saw in a tree.** Operation of a chain saw while up in a tree may result in personal injury.
- 6. Always keep proper footing and operate the chain saw only when standing on fixed, secure and level surface.** Slippery or unstable surfaces such as ladders may cause a loss of balance or control of the chain saw.
- 7. When cutting a limb that is under tension be alert for spring back.** When the tension in the wood fibers is released the spring loaded limb may strike the operator and/or throw the chain saw out of control.
- 8. Use extreme caution when cutting brush and saplings.** The slender material may catch the saw chain and be whipped toward you or pull you off balance.
- 9. Carry the chain saw by the front handle with the chain saw switched off and away from your body. When transporting or storing the chain saw always apply the guide bar cover.** Proper handling of the chain saw will reduce the likelihood of accidental contact with the moving saw chain.
- 10. Follow instructions for lubricating, chain tensioning and changing accessories.** Improperly tensioned or lubricated chain may either break or increase the chance for kickback.
- 11. Keep handles dry, clean, and free from oil and grease. Greasy, oily handles are slippery causing loss of control.**
- 12. Cut wood only. Do not use chain**

saw for purposes not intended. For example: do not use chain saw for cutting plastic, masonry or non-wood building materials. Use of the chain saw for operations different than intended could result in a hazardous situation.

CAUSES AND OPERATOR PREVENTION OF KICKBACK:

Kickback may occur when the nose or tip of the guide bar touches an object, or when the wood closes in and pinches the saw chain in the cut. Tip contact in some cases may cause a sudden reverse reaction, kicking the guide bar up and back towards the operator.

Pinching the saw chain along the top of the guide bar may push the guide bar rapidly back towards the operator.

Either of these reactions may cause you to lose control of the saw which could result in serious personal injury. Do not rely exclusively upon the safety devices built into your saw.

As a chain saw user, you should take several steps to keep your cutting jobs free from accident or injury.

Kickback is the result of tool misuse and/or incorrect operating procedures or conditions and can be avoided by taking proper precautions as given below:

- **Maintain a firm grip, with thumbs and fingers encircling the chain saw handles, with both hands on the saw and position your body and arm to allow you to resist kickback forces.** Kickback forces can be controlled by the operator, if proper precautions are taken. Do not let go of the chain saw.
- **Do not overreach and do not cut above shoulder height.** This helps prevent unintended tip contact and enables better control of the chain saw in unexpected situations.
- **Only use replacement bars and chains specified by the manufacturer.** Incorrect replacement bars and chains may cause chain breakage and/or kickback.
- **Follow the manufacturer's sharpening and maintenance instructions for the saw chain.** Decreasing the depth gauge height can lead to increased kickback.

SAFETY RULES FOR EXTENSION CORD

Make sure your extension cord is in good condition. When using an extension cord, be sure to use one heavy enough to carry the current your product will draw. An undersized extension cord will cause a drop in line voltage resulting in loss of power and overheating. Table 1 shows the correct size to use depending on cord length and nameplate ampere rating. If in doubt, use the next heavier gage. The smaller the gage number, the heavier the cord. To reduce the risk of disconnection of appliance cord from the extension cord during operating:

- I) Make a knot as shown in Figure 1; or
- II) Use one of the plug-receptacle retaining straps or connectors described in this manual.

Table 1 Minimum gauge for extension cords

Volts	Total length of cord in feet			
	25	50	100	150
120V	25	50	100	150
240V	50	100	200	300
Ampere rating more than not more than	AWG			
0-6	18	16	16	14
6-10	18	16	14	12
10-12	16	16	14	12
12-16	14	12	Not recommended	

NOTE: Only the applicable parts of the Table need to be included. For instance, a 120-volt product need not include the 240-volt heading.

Figure 1 METHOD OF SECURING EXTENSION CORD

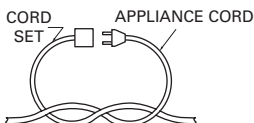

(A) TIE CORD AS SHOWN

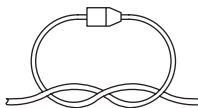

(B) CONNECT PLUG AND RECEPTACLE

! For chain saw with the extended pole safety warnings

IMPORTANT SAFETY INSTRUCTIONS

! **WARNING:** When using electric gardening appliances, basic safety precautions should always be followed to reduce the risk of fire, electric shock, and personal injury, including the following:

! **WARNING:** Read all instructions

FOR ALL APPLIANCES

- 1) **Avoid dangerous environment.** Don't use appliances in damp or wet locations.
- 2) **Don't use in rain.**
- 3) **Keep children away.** All visitors should be kept at a distance from work area.
- 4) **Dress properly.** Do not wear loose clothing or jewelry. They can be caught in moving parts. Use of gloves and substantial footwear is recommended when working outdoors. Wear protective hair covering to contain long hair.
- 5) **Use safety glasses.** Always use eye protection plus a dust mask if operation is dusty.
- 6) **Use right appliance.** Do not use appliance for any job except that for which it is intended.
- 7) **Ground Fault Circuit Interrupter (GFCI) protection should be provided on the circuit(s) or outlet(s) to be used for the gardening appliance.** Receptacles are available having built-in GFCI protection and may be used for this measure of safety.
- 8) **!** **WARNING!** To reduce the risk of electric shock, use only with an extension cord intended for outdoor use, such as an extension cord of cord type SW-A, SOW-A, STW-A, STOW-A, SJW-A,

SJOW-A, SJTW-A. or SJTOW-A.

- 9) Avoid Unintentional Starting - Don't carry plugged-in appliance with finger on switch.** Be sure switch is off when plugging in.
- 10) Don't Abuse Cord - Never carry appliance by cord or yank it to disconnect from receptacle.** Keep cord from heat, oil, and sharp edges.
- 11) Don't grasp the exposed cutting blades or cutting edges when picking up or holding the appliance.**
- 12) Don't Force Appliance - It will do the job better and with less likelihood of a risk of injury at the rate for which it was designed.**
- 13) Don't Overreach - Keep proper footing and balance at all times.**
- 14) Stay Alert - Watch what you are doing.** Use common sense. Do not operate appliance when you are tired.
- 15) Disconnect Appliance - Disconnect the appliance from the power supply when not in use, before servicing, when changing accessories such as blades, and the like.**
- 16) Store Idle Appliances Indoors -** When not in use, appliances should be stored indoors in dry, and high or locked-up place - out of reach of children.
- 17) Maintain Appliance With Care - Keep cutting edge sharp and clean for best performance and to reduce the risk of injury.** Follow instructions for lubricating and changing accessories. Inspect appliance cord periodically, and if damaged, have it repaired by an authorized service facility. Inspect extension cords periodically and replace if damaged. Keep handles dry, clean, and free from oil and grease.
- 18) Check Damaged Parts - Before further use of the appliance, a guard or other part that is damaged should be carefully checked to determine that it will operate properly and perform its intended function.** Check for alignment of moving parts, binding of moving parts, breakage of parts, mounting, and any other condition that

may affect its operation. A guard or other part that is damaged should be properly repaired or replaced by an authorized service center unless indicated elsewhere in this manual.

SAVE THESE INSTRUCTIONS

FOR ALL DOUBLE-INSULATED APPLIANCES

1) Replacement Parts.

When servicing use only identical replacement parts.

2) Polarized Appliance Connections

To reduce the risk of electric shock, this appliance has a polarized plug (one blade is wider than the other) and will require the use of a polarized extension cord. The appliance plug will fit into a polarized extension cord only one way. If the plug does not fit fully into the extension cord, reverse the plug.

If the plug still does not fit, obtain a correct polarized extension cord. A polarized extension cord will require the use of a polarized wall outlet. This plug will fit into the polarized wall outlet only one way. If the plug does not fit fully into the wall outlet, reverse the plug. If the plug still does not fit, contact a qualified electrician to install the proper wall outlet. Do not change the equipment plug, extension cord receptacle, or extension cord plug in any way.

Keep the pole chain saw a sufficient distance away from electrical power lines.

INSTRUCTIONS CONCERNING THE PROPER TECHNIQUES FOR BASIC FELLING, LIMBING, AND CROSS-CUTTING

1. Felling a tree

When bucking and felling operations are being performed by two or more persons at the same time, the felling operations should be separated from the bucking operation by a distance of at least twice the height of the tree being felled. Trees should not be felled in a manner that would endanger any person, strike any utility line or cause any property

damage. If the tree does make contact with any utility line, the company should be notified immediately.

The chain saw operator should keep on the uphill side of the terrain as the tree is likely to roll or slide downhill after it is felled.

An escape path should be planned and cleared as necessary before cuts are started. The escape path should extend back and diagonally to the rear of the expected line of fall as illustrated in Figure I.

Before felling is started, consider the natural lean of the tree, the location of larger branches and the wind direction to judge which way the tree will fall.

Remove dirt, stones, loose bark, nails, staples and wire from the tree.

2. Notching undercut

Make the notch 1/3 the diameter of the tree, perpendicular to the direction of fall as illustrated in Figure I. Make the lower horizontal notching cut first. This will help to avoid pinching either the saw chin or the guide bar when the second notch is being made.

3. Felling back cut

Make the felling back cut at least 50 mm higher than the horizontal notching cut as illustrated in Figure I. Keep the felling back cut parallel to the horizontal notching cut. Make the felling back cut so enough wood is left to act as a hinge. The hinge wood keeps the tree from twisting and falling in the wrong direction. Do not cut through the hinge.

As the felling gets close to the hinge, the tree should begin to fall. If there is any chance that the tree may not fall in desired direction or it may rock back and bind the saw chain, stop cutting before the felling back cut is complete and use wedges of wood, plastic or aluminium to open the cut and drop the tree along the desired line of fall.

When the tree begins to fall remove the chain saw from the cut, stop the motor, put the chain saw down, then use the retreat path planned. Be alert for overhead limbs falling and watch your footing.

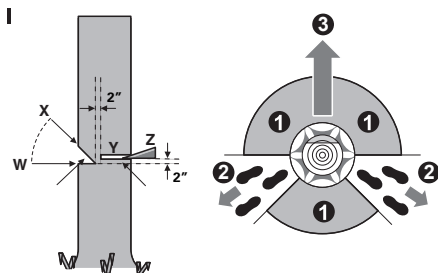

4. Limbing a tree

Limbing is removing the branches from a fallen tree. When limbing leave larger lower limbs to support the log off the ground. Remove the small limbs in one cut as illustrated in Figure II. Branches under tension should be cut from the bottom up to avoid binding the chain saw.

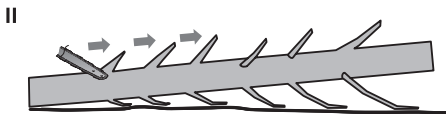

5. Bucking a log

Bucking is cutting a log into lengths. It is important to make sure your footing is firm and your weight is evenly distributed on both feet. When possible, the log should be raised and supported by the use of limbs, logs or chocks. Follow the simple directions for easy cutting.

When the log is supported along its entire length as illustrated in Figure III, it is cut from the top (overbuck).

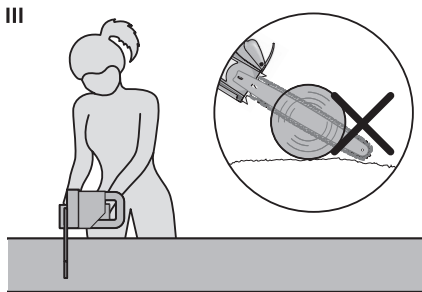

When the log is supported on one end, as illustrated in Figure IV, cut 1/3 the diameter from the underside (underbuck). Then make the finished cut by overbucking to meet the first cut.

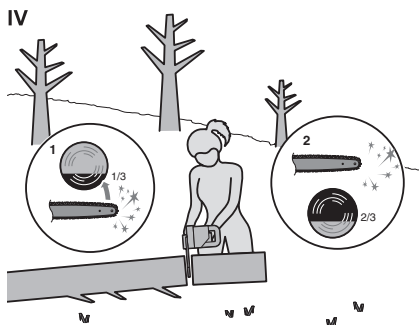

When the log is supported on both ends, as illustrated in Figure V, cut 1/3 the diameter from the top (overbuck). Then make the finished cut by underbucking the lower 2/3 to meet the first cut.

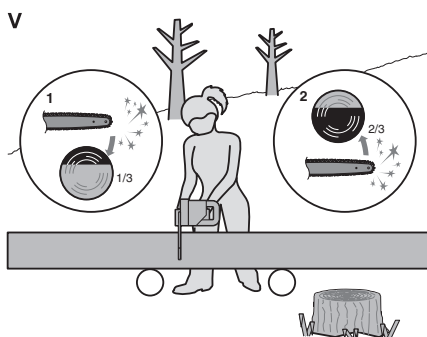

When bucking on a slope always stand on the uphill side of the log, as illustrated in Figure VI. When “cutting through,” to maintain complete control release the cutting pressure near the end of the cut without relaxing your grip on the chain saw handles. Don’t let the chain contact the ground. After completing the cut, wait for the saw chain to stop before you move the chain saw. Always stop the motor before moving from tree to tree.



SYMBOL



To reduce the risk of injury, user must read instruction manual



Wear head protection



Wear ear protection



Protective gloves



Wear eye protection



Protective footwear



Wear dust mask



Warning of danger from overhead electric-power lines



Double insulation



Do not expose to rain



Remove plug from the mains immediately if the cable is damaged or cut.



Contact of the guide bar tip with any object should be avoided



Tip contact can cause the guide bar to move suddenly upward and backward, which can cause serious injury



Always use two hands when operating the chain saw



ASSEMBLY



WARNING! Do not connect the chain saw to the power supply before it is completely assembled. Always use gloves when handling the chain.

CHAIN AND GUIDE BAR ASSEMBLY

1. Unpack all parts carefully.
2. Place the chain saw on a solid, level surface.
- 3. Use only genuine WORX chains designed for Guide Bar.**
4. Slide the Chain(10) in the slot around the Guide Bar (9). Ensure the Chain is in correct running direction by comparing it to the Chain Direction Symbol (16) found on the saw body. Ensure the Bar Tensioning Plate (22) is facing outward. (See Fig. A)
5. Fit the Chain onto the Drive Sprocket (15), so that the Fastening Bar Bolt (19) and the two Bar Locating Tabs (20) on the Bar Clamp (18) fit into the keyway of the opening on the Guide Bar (9). (See Fig. B)
6. Check to see if all parts are seated properly. (See Fig. C)
NOTE: Chain should rotate freely and be free of kinks.
7. Fit the Chain Cover (12) and tighten the Chain Cover by turning the Chain Tensioning Knob (11) clockwise until it is tight. (See Fig. D)



WARNING: The chain is not yet tensioned. Tensioning the chain applies as described under "TENSIONING CHAIN". The chain now needs to be inspected to make sure it is properly tensioned.

TENSIONING CHAIN (See Fig. E)

NOTE: New saw chains will stretch. Check the chain tension frequently when first used and tighten when the Chain (10) becomes loose around the Guide Bar (9).



WARNING:
• **Unplug chain saw from power source**

before adjusting saw chain tension.

- **Cutting edges on chain are sharp. Use protective gloves when handling chain.**
 - **Maintain proper chain tension always. A loose chain will increase the risk of kickback. A loose chain may jump out of guide bar groove. This may injure operator and damage chain. A loose chain will cause chain, bar, and sprocket to wear rapidly.**
1. Place the chain saw on any suitable flat surface.
 2. Turn the Chain Tensioning Knob (11) clockwise until it is hand tight. The tension is automatically set while the Chain Tensioning Knob is being tightened. The ratchet mechanism prevents the chain tension from loosening.
 3. Double check the tension set by the automatic Chain Tensioning Knob. The correct chain tension is reached when the Chain (10) can be raised approx. 0.12–0.24" (3-6mm) from the Guide Bar (9) in the center. This should be done by using one hand to raise the chain against the weight of the machine.
 4. The Chain will stretch from use and lose proper tension. To turn knob counter clockwise (3x), secure the chain cover, and retension the chain simply repeat steps 1 - 3 listed above.

ASSEMBLING THE EXTENSION POLE

Align and insert the handle of extension pole into the shaft. Rotate the locking collar clockwise to lock. (See Fig. F)

NOTE: Make sure that the shaft is firmly locked in place.

ASSEMBLING THE EXTENSION POLE TO THE MACHINE

1. Insert the pole bracket into the saw. (See Fig. G1)
NOTE: Pole bracket holds trigger in "ON" position.
2. Slide the handle bracket onto clamping bolt.
3. Screw the knob tightly. (See Fig. G2)
4. Plug saw power cord into receptacle cord

at end of inner pole.(See Fig. G2)



WARNING!

- **Before attaching the power cord of the machine to the power cord of the Extension Pole, make sure that the tool is switched off and unplugged from the power supply.**
- **When using this machine with the Extension Pole, make sure to first attach the power cord of the machine to the power cord of the extension pole, and then attach the power cord of the extension pole to power supply.**
- **ELECTROCUTION HAZARD: Never use the Saw or Extension Pole in an area with overhead power lines or where the branch being cut can come into contact with overhead power lines.**

ADJUSTING POLE LENGTH

The pole saw has a telescoping pole assembly that will extend from 87 inches (fully retracted) to 117 inches (fully extended). A cam levered collet is used to hold the pole in position at any extended length.

1. To extend the pole, loosen the clamping lever as shown in Fig H. Pole will slide freely.
2. Pull inner pole section out to desired length of extension. Note: only extend pole to minimum length required to reach limb that is being cut.
3. To lock pole in position, tighten clamping lever as shown in Fig. H.

LUBRICATION



IMPORTANT: The chain saw is not supplied filled with oil. It is essential to fill with oil before use. Never operate the chain saw without chain oil or at an empty oil tank level, as this will result in extensive damage to the product.

NOTE: Chain life and cutting capacity depend on optimum lubrication. Therefore, the chain is automatically oiled during operation.

Filling oil tank:

1. Set chain saw on any suitable surface with Oil Filler Cap (5) facing upward.
2. Clean area around the Oil Filler Cap with cloth and unscrew the cap by turning it counter clockwise.
3. Add WORX bar and chain oil until reservoir is full.
4. Avoid dirt or debris entering oil tank, refill Oil Filler Cap (5) and tighten by turning clockwise until hand tight.



IMPORTANT: To allow venting of the oil reservoir, small breather channels are provided between the Oil Filler Cap and the strainer, to prevent leakage ensure machine is left in a horizontal position (Oil Filler Cap (5) uppermost) when not in use. It is important to use only the recommended oil (ISO VG32) to avoid damage to the chain saw. Never use recycled/old oil. Use of non approved oil will invalidate the warranty.

Checking the Automatic Oiler

Proper functioning of the automatic oiler can be checked by running the chain saw and pointing the tip of the Guide chain bar (7) towards a piece of cardboard or paper on the ground. If an increasing oil pattern develops on the cardboard, the automatic oiler is operating fine. If there is no oil pattern, despite a full oil reservoir, contact WORX customer service agent or WORX approved service agent.



CAUTION: Do not touch the ground with the chain. Ensure safety clearance of 12".

OPERATION

1. SWITCHING ON AND OFF (See Fig. I)



ATTENTION: Check the voltage and current supply: The voltage and current supply must comply with the ratings on the product plate.

For **switching on the tool**, press the Lock-off Button (3), then fully press the On/Off Switch (2) and hold in this position. The Lock-Off Button can now be released.

For **switching off**, release the On/Off Switch.

2. CUTTING

 **IMPORTANT: Is the oil reservoir filled? Check the Oil Level Window (4) prior to starting and regularly during operation. Refill oil when oil level is low. A full oil tank will last approx. 12 minutes depending on sawing intensity and stops (See Fig. J1). Check recent replaced chain tension about every 10 minutes during operation."**

- (1) Connect saw to extension cord. Connect extension cord to power supply. (See Fig. J2)
- (2) Make sure section of log to be cut is not laying on the ground. This will keep the chain (10) from touching the ground as it cuts through the log. Touching the ground while the Chain is moving is dangerous and will dull the Chain.
- (3) Use both hands to grip saw. Always use left hand to grip Front Handle(6)and right hand to grip Rear Handle (1). Use a firm grip. Thumbs and fingers must wrap around saw handles (See Fig.J3).
- (4) Make sure your footing is firm. Keep shoulder width feet apart. Divide your weight evenly on both feet.
- (5) When ready to make a cut, push the Lock-off Button (3) completely in with the right thumb and squeeze the trigger. This will turn saw on. Releasing the trigger will turn the saw off. Make sure the saw is running at full speed before starting a cut.
- (6) When starting a cut, slowly place moving chain against the wood. Hold saw firmly in place to avoid possible bouncing or skating (sideways movement) of saw.
- (7) Guide the saw using light pressure and do not put excessive force on the saw. The motor will overload and can burn out. It will do the job better and safer at the rate for which it was intended.
- (8) Remove the saw from a cut with the saw running at full speed. Stop the saw by releasing the On/off Switch (2). Make sure the chain has stopped before setting the

saw down.

- (9) Keep practicing on scrap logs in a secure working area until you get the hang of it and can saw with ease, using a fluid motion and a steady cutting rate.

KICKBACK SAFETY DEVICES ON THIS SAW

This saw has a low-kickback chain and reduced kickback Guide Bar. Both items reduce the chance of kickback. However, kickback can still occur with this saw.

The following steps will reduce the risk of kickback.

- Use both hands to grip saw while saw is running. Use firm grip. Thumbs and fingers must wrap around saw handles.
- Keep all safety items in place on saw. Make sure they work properly.
- Do not overreach or cut above shoulder height.
- Keep solid footing and balance at all times.
- Stand slightly to left side of saw. This keeps your body from being in direct line with chain.
- Do not let Guide Bar nose touch anything when chain is moving.
- Never try cutting through two logs at same time. Only cut one log at a time.
- Do not bury the Guide Bar nose or try plunge cut (boring into wood using Guide Bar nose).
- Watch for shifting of wood or other forces that may pinch chain.
- Use extreme caution when reentering a previous cut.
- Use only the low-kickback chain and Guide Bar(9)that were supplied with this chain saw.
- Never use a dull or loose chain. Keep chain sharp with proper tension.

HOW TO USE SAW SAFELY

1. Use the chain saw only with secure footing.
2. Hold the chain saw at the right-hand side of your body (See Fig. K1).
3. The Chain(10)must be running at full speed before it makes contact with the wood.
4. Use the metal Bumper Spikes (8) to secure the saw onto the wood before starting to cut.

5. Use the Bumper Spikes as a leverage point (a) while cutting. (See Fig. K2)
6. Do not operate the chain saw with arms fully extended, attempt to saw areas which are difficult to reach, or stand on a ladder while sawing (see Fig. K3).

Never use the chain saw above shoulder height

CUTTING WOOD UNDER TENSION (See Fig. L)



WARNING: When cutting a limb that is under tension, use extreme caution. Be alert for wood springing back. When wood tension is released, limb could spring back and strike operator causing severe injury or death.

When sawing logs supported on both ends, start the cut from above (Y) about 1/3 of the diameter into the log and then finish the cut (Z) from below, in order to avoid contact of the chain saw with the ground. When sawing logs supported on only one end, start the cut from below (Y) about 1/3 of the diameter into the log and finish the cut from above (Z) in order to avoid log splitting or jamming of the chain saw.

5. When ready to make a cut, press the Lock-off Button, then fully press the On/off Switch (See Figure M6). This will turn Pole Saw on. Releasing On/off Switch will turn Pole Saw off. Make sure saw is running at full speed before starting a cut.
6. When starting a cut, place moving chain against wood. Hold Pole Saw firmly in place to avoid possible bouncing or skating (sideways movement) of saw.
7. Guide Pole Saw using light pressure. Do not force Pole Saw. The motor will overload and can burn out. It will do the job better and safer at the rate for which it was intended.
8. Remove Pole Saw from a cut with saw running at full speed. Stop Pole Saw by releasing trigger. Make sure chain has stopped before setting Pole Saw down.

TRIMMING A TREE (PRUNING)



WARNING: Avoid kickback. Kickback can result in severe injury or death.

See Kickback, to avoid risk of kickback.

WARNING: Do not operate Pole Saw while

- in a tree
- on a ladder or any other unstable surface
- in any awkward position

You may lose control of Pole Saw causing severe injury.



WARNING: Do not extend arms above shoulders when using Pole Saw.

CAUTION: Seek professional help if facing conditions beyond your ability.

Trimming a tree is the process of cutting limbs from a living tree. Make sure your footing is firm. Keep feet apart. Divide your weight evenly on both feet.

Follow directions below to trim a tree.

OPERATION FOR POLE SAW

Cutting with extension pole

1. Connect saw to extension cord. Connect extension cord to power supply.
2. Before cutting a high branch, consider all the same points detailed in the previous section "Trimming Branches" but pay particular attention to the likely path of the falling branch.



WARNING: Do not stand directly below a branch being cut. Keep bystanders far away. Do not stand on a ladder or other type of unstable support while using the tool. Do not use the tool near cable, electrical power or telephone lines. Keep 10 ft (3m) away from all power lines. (See Fig. M1-M4)

3. Use both hands to grip Pole Saw. Use only designated grip areas when operating Pole Saw (See Figure M5). Use firm grip. Thumbs and fingers must wrap around Pole Saw handle and pole.
4. Make sure your footing is firm. Keep feet

3. Make third cut as close to tree trunk as possible on underside of limb stub. Use top of guide bar to make this cut. Cut 1/3 through diameter of stub.
4. Make fourth cut directly above third cut. Cut down to meet third cut. This will remove limb stub.

SAW MAINTENANCE

Follow maintenance instructions in this manual. Proper cleaning of saw and chain and Guide Bar maintenance can reduce chances of kickback. Inspect and maintain saw after each use. This will increase the service life of your saw.

NOTE: Even with proper sharpening, risk of kickback can increase with each sharpening.

MAINTENANCE AND STORAGE OF CHAIN SAW

If the replacement of the supply cord is necessary, this has to be done by the manufacturer or his agent in order to avoid a safety hazard.

1. Unplug chain saw from power source

- When not in use
- Before moving from one place to another
- Before servicing
- Before changing accessories or attachments, such as saw chain and guard

2. Inspect chain saw before and after each use.

Check saw closely if guard or other part has been damaged. Check for any damage that may affect operator safety or operation of saw. Check for alignment or binding of moving parts. Check for broken or damaged parts. Do not use chain saw if damage affects safety or operation. Have damage repaired by authorized service center. To locate an authorized service center, visit www.worx.com

3. Maintain chain saw with care.

- Never expose saw to rain.
- Keep chain sharp, clean, and lubricated for better and safer performance.
- Follow steps outlined in this manual to sharpen chain.
- Keep handles dry, clean, and free of oil and

grease.

- Keep all screws and nuts tight.
- Inspect power cord often. If damaged, have repaired by authorized service center.
- Never carry chain saw by power cord.
- Never yank power cord to unplug it.
- Keep power cord from heat, oil, and sharp edges.
- Inspect extension cords often and replace if damaged.

4. When servicing, use only identical replacement parts.

5. When not in use, always store chain saw

- in a high or locked place, out of children's reach
- in a dry place

Bar Maintenance

To maximize bar life, the following bar maintenance is recommended.

The bar rails that carry the chain should be cleaned before storing the tool or if the bar or chain appear to be dirty.

The rails should be cleaned every time the chain is removed.

Turn the bar over, top rail becoming bottom and bottom rail becoming top, around every 5 hours of use.

To clean the Bar rails:

1. Remove chain cover and bar and chain. (see section ASSEMBLY)
2. Using a wire brush, screwdriver or similar tool, clear the residue from the inner groove of the bar (See Fig. N).
3. Make sure to clean oil passages thoroughly

Conditions which require Guide Bar(9) maintenance:

- Saw cuts to one side or at an angle.
- Saw has to be forced through the cut.
- Inadequate supply of oil to the bar and chain.

Check the condition of the guide bar each time the chain is sharpened. A worn guide bar will damage the chain and make cutting difficult.

After each use, with unit disconnected from power source, clean all sawdust from the guide bar and sprocket hole.

When rail top is uneven, use a flat file to restore square edges and sides.

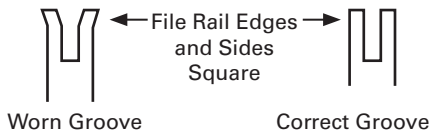

Replace the guide bar when the groove is worn, the guide bar is bent or cracked, or when excess heating or burring of the rails occurs. If replacement is necessary, use only the guide bar specified for your saw in the repair parts list or on the decal located on the chain saw.

Replacing Bar & Chain

Replace chain when cutters are too worn to sharpen or when chain stops. Only use replacement chain noted in this manual. Always include new Drive Sprocket(15) when replacing chain. This will maintain proper driving of chain.

Inspect Guide Bar before sharpening chain. A worn or damaged Guide Bar is unsafe. A worn or damaged Guide Bar will damage chain. It will also make cutting harder.

Fit the Bar Tensioning Plate (22) catch into the new bar by tightening the screw clockwise. The catch protrude (a) must be fitted into the bar hole. (See Fig. O)

SHARPENING SAW CHAIN

WARNING: Unplug chain saw from power source before servicing. Severe injury or death could occur from electrical shock or body contact with moving chain.

Cutting edges on chain are sharp. Use protective gloves when handling chain.

Keep chain sharp. Your saw will cut faster and more safely. A dull chain will cause undue sprocket, guide bar, chain, and motor wear. If you must force chain into wood and cutting creates only sawdust with few large chips, chain is dull.

LUBRICATE SPROCKET

WARNING: Wear heavy duty gloves when performing any maintenance or service to this tool. Always unplug the tool before performing any service or maintenance on this tool.

NOTE:

It is not necessary to remove the chain or bar when lubricating the sprocket

1. Clean the bar and sprocket
2. Using a grease gun, insert the tip of the gun into the lubrication hole and inject grease until it appears at the outside edge of the sprocket tip (See Fig. P).
3. To rotate the sprocket release the chain stop and pull the chain by hand until the ungreased side of the sprocket is in line with the grease hole. Repeat the lubrication procedure.

TROUBLESHOOTING TABLE

The following table gives checks and actions that you can perform if your machine does not operate correctly. If these do not identify/remedy the problem, contact your service agent.

WARNING: Switch off and remove plug from mains before investigating fault.

Symptom	Possible Cause	Remedy
Chain saw fails to operate	No power Mains socket faulty Extension cord damaged Fuse faulty	Check power Use another socket Check cord, replace Replace fuse
Chain saw operates intermittently	Extension cord damaged Loose connection Internal wiring defective On/Off switch defective	Check cord, replace Contact service agent 1-866-354-WORX (9679) Contact service agent 1-866-354-WORX (9679) Contact service agent 1-866-354-WORX (9679)
Dry chain	No oil in reservoir Vent in oil filler cap clogged Oil passage clogged	Refill oil Clean cap Clean oil passage outlet
Chain/chain bar over-heats	No oil in reservoir Vent in oil filler cap clogged Oil passage clogged Chain is over tensioned Dull chain	Refill oil Clean cap Clean oil passage outlet Adjust chain tension Sharpen chain or replace
Chain saw rips, vibrates, does not saw properly	Chain tension too loose Dull chain Chain worn out Chain teeth are facing in the wrong direction	Adjust chain tension Sharpen chain or replace Replace chain Reassemble with chain in correct direction